

COBY®

TF-TV3207

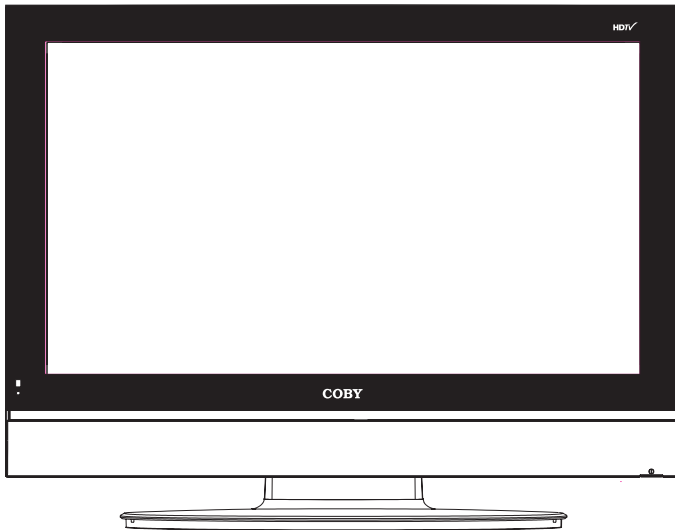

32" Widescreen TFT LCD High-Definition Television



Instruction Manual

Please read this manual carefully before operation.

PRECAUTIONS

	CAUTION WARNING: SHOCK HAZARD. DO NOT OPEN. AVIS: RISQUE DE CHOC ELECTRIQUE. NE PAS OUVRIR	
CAUTION: TO REDUCE THE RISK OF FIRE AND ELECTRIC SHOCK, DO NOT REMOVE THE COVER (OR BACK) OF THE UNIT. REFER SERVICING ONLY TO QUALIFIED SERVICE PERSONNEL.		

For Customer Use:

Enter below the serial number that is located on the rear of the unit. Retain this information for future reference.

Model No. TF-TV3207

Serial No. _____



The lightning flash with arrowhead symbol within an equilateral triangle is intended to alert the user to the presence of uninsulated "dangerous voltage" within the product's enclosure that may be of sufficient magnitude to constitute a risk of electric shock.



The exclamation point within an equilateral triangle is intended to alert the user to the presence of important operation and servicing instructions in the literature accompanying the appliance.

WARNING:

To prevent fire or shock hazard, do not expose this device to rain or moisture. Dangerous high voltage is present inside the enclosure. Do not open the cabinet.

FCC Notice:

This equipment has been tested and found to comply with the limits for a Class B digital device pursuant with the FCC Rules, Part 15. These limits are designed to provide reasonable protection against harmful interference in a residential installation. This equipment generates, uses, and can radiate radio frequency energy, and if not installed and used in accordance with the instructions may cause harmful interference to radio communication.

CAUTION:

To prevent electric shock, match wide blade of plug to wide slot of outlet and fully insert.

NOTE:

Before plugging the power cord into an AC outlet, make sure that all the connections have been made.

NOTE:

The LCD panel used in this television contains millions of thin film transistors that have been manufactured using a high-technology process to deliver a crisp, clear, and detailed picture. Occasionally, a few of these transistors may become stuck or non-active; please note that this does not affect the performance of the television.



For recycling or disposal information about this product, please contact your local authorities or the Electronics Industries Alliance: www.eiae.org.

IMPORTANT SAFETY INSTRUCTIONS

1. **Read Instructions:** All the safety and operating instructions should be read before the product is operated.
2. **Retain Instructions:** The safety and operating instructions should be retained for future reference.
3. **Heed Warnings:** All warnings on the product and in the operating instructions should be adhered to.
4. **Follow Instructions:** All operating and usage instructions should be followed.
5. **Cleaning:** Unplug this product from the wall outlet before cleaning. Do not use liquid cleaners or aerosol cleaners. Use a damp cloth for cleaning.
6. **Attachments:** Use only attachments recommended by the manufacturer. Use of other attachments may be hazardous.
7. **Water and Moisture:** Do not use this product near water (e.g., near a bath tub, washbowl, kitchen sink, laundry tub, in wet basements, or near a swimming pool and the like).
8. **Accessories:** Do not place this product on an unstable cart, stand, tripod, bracket, or table. Use only with carts, stands, tripods, brackets, or tables recommended by the manufacturer or sold with the product. Any mounting of the product should follow the manufacturer's instructions and should use a mounting accessory recommended by the manufacturer.
9. A product and cart combination should be moved with care. Quick stops, excessive force, and uneven surfaces may cause the product and cart combination to overturn.
10. **Ventilation:** Slots and openings in the cabinet are provided for ventilation to ensure reliable operation of the product and to protect it from overheating. These openings should never be blocked by placing the product on a bed, sofa, rug, or other similar surface. This product should not be placed in a built-in installation such as a bookcase or rack unless proper ventilation is provided or the manufacturer instructions have been adhered to.
11. **Power Sources:** This product should be operated only from the type of power source indicated on the rating label. If you are not sure of the type of power supply to your home, consult your product dealer or local power company. For products intended to operate from battery power or other sources, refer to the operating instructions.
12. **Grounding or Polarization:** This product may be equipped with a polarized alternating-current line plug that has one blade wider than the other. This plug will only fit into the power outlet in one direction. This is a safety feature. If you are unable to insert the plug fully into the outlet, try reversing the direction of the plug. If the plug should still fail to fit, contact an electrician to replace the obsolete outlet. Do not defeat the safety purpose of the polarized plug.
13. **Power-Cord Protection:** Power supply cords should be routed so that they are not likely to be walked on or pinched by items placed upon or against them, paying particular attention to cords at plugs, convenience receptacles, and at the point which they exit from the product.
14. **Protective Attachment Plug:** The product may be equipped with an attachment plug with overload protection. This is a safety feature. See the operating instructions for replacement or directions to reset the protective device. If replacement of the plug is required, be sure the service technician has used a replacement plug that has the same overload protection as the original plug as specified by the manufacturer.



IMPORTANT SAFETY INSTRUCTIONS

- Outdoor Antenna Grounding: If an outside antenna is connected to the product, be sure the antenna system is grounded so as to provide some protection against voltage surges and built-up static charges. Article 810 of the National Electrical Code, ANS/NFPA 70 provides information with regard to proper grounding of the mast and supporting structure, grounding of the lead-in wire to an antenna-discharge unit, size of grounding conductors, location of antenna-discharge unit, connection to grounding electrodes, and requirements for the grounding electrode (see figure).

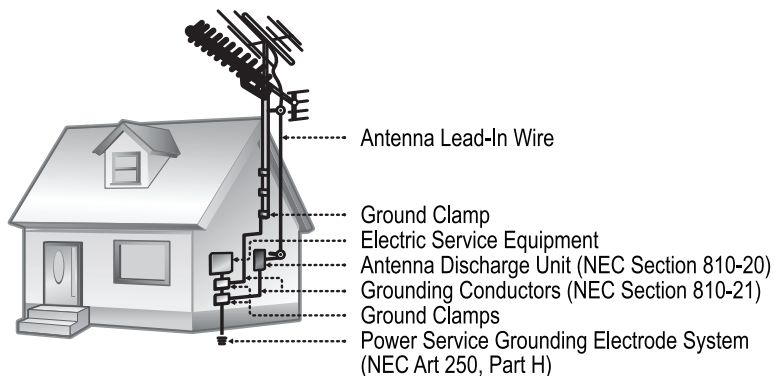

- Lightning: For added protection for this product, unplug it from the wall outlet and disconnect the antenna or cable system during a lightning storm or when it is left unattended and unused for long periods of time. This will prevent damage to the product due to lightning or power-line surges.
- Power Lines: An outside antenna system should not be located in the vicinity of overhead power lines or other electric light or power circuits, or where it can fall into such power lines or circuits. When installing an outside antenna system, extreme care should be taken to keep from touching such power lines or circuits, as contact with them might be fatal.
- Overloading: Do not overload wall outlets, extension cords, or integral convenience receptacles as this can result in a risk of fire or electric shock.
- Object and Liquid Entry: Never push objects of any kind into this product through openings as they may touch dangerous voltage points or short-out parts that could result in a fire or electric shock. Never spill liquid of any kind on the product.
- Service: Do not attempt to service this product yourself as opening or removing covers may expose you to dangerous voltage or other hazards. Refer all servicing to qualified service personnel.
- Damage Requiring Service: Unplug this product from the wall outlet and refer servicing to qualified service personnel under the following conditions: a) when the power-supply or plug is damaged; b) if liquid has been spilled or if objects have fallen into the product; c) if the product has been exposed to rain or water; d) if the product does not operate normally by following the operating instructions. Adjust only those controls that are covered by the operating instructions as improper adjustment of other controls may result in damage and will often require extensive work by a qualified technician to restore the product to its normal operation; e) if the product has been dropped or damaged in any way; f) when the product exhibits a distinct change in performance—this indicates a need for service.

IMPORTANT SAFETY INSTRUCTIONS

22. **Replacement Parts:** When replacement parts are required, be sure that your service technician has used replacement parts specified by the manufacturer or have the same characteristics as the original part. Unauthorized substitutions may result in fire, electric shock, or other hazards.
23. **Safety Check:** Upon completion of any service or repairs to this product, ask the service technician to perform safety checks to ensure that the product is in proper operating condition.
24. **Wall or Ceiling Mounting:** The product should be mounted to a wall or ceiling only as recommended by the manufacturer.
25. **Heat:** The product should be situated away from heat sources such as radiators, heat registers, stoves, or other products (including amplifiers) that produce heat.

TABLE OF CONTENTS

PRECAUTIONS	2
IMPORTANT SAFETY INSTRUCTIONS	3
TABLE OF CONTENTS	6
FEATURES	8
PACKAGE CONTENTS	9
LOCATION OF CONTROLS	10
Front View	10
Right Panel View	10
Rear Panel View	11
Remote Control	12
GETTING STARTED	14
Audio/Video Input Connections	14
TV Antenna (DTV, TV)	14
Composite Video or S-Video (Video, S-Video)	14
Component Video (Component 1, Component 2)	15
HDMI (HDMI)	15
15-Pin D-Sub (PC)	16
Audio/Video Output Connections	16
Power Connection	16
Remote Control	17
Power Management	17
TV FUNCTION	18
Basic Operation	18
System Setup Menu	18
Picture Options Menu	18
Audio Options Menu	19
Channel Options Menu	19
Setup Options Menu	19
Time Options Menu	20
Favorite Channels List	20
Parental Control (V-Chip Lock)	21
Parent Guide Options (TV Rating)	22
MPAA Options (Movie Rating)	22
AV FUNCTION	23
Basic Operation	23
System Setup Menu (AV Mode)	23
Picture Options Menu	23
Audio Options Menu	24
Setup Options Menu	24
Time Options Menu	24

TABLE OF CONTENTS

PC VGA FUNCTION	25
Basic Operation	25
System Setup Menu (PC Mode)	25
Picture Options Menu	25
Audio Options Menu	26
Setup Options Menu	26
Time Options Menu.....	26
TROUBLESHOOTING.....	27
SPECIFICATIONS	29

FEATURES

- 32" Widescreen TFT LCD Color Display
- Fast 8ms Pixel Response Time
- ATSC and NTSC Tuner Receives HD and Regular TV Broadcasts
- Native 720p Resolution (Accepts HDTV Signals up to 1080i)
- HDMI Digital Connection for Perfect Digital AV Signal Transmission
- HDCP Compliance for HDCP Content Support
- Digital and Analog AV Connections for use with Home Theater Systems
- 15-pin VGA Interface for use with Computer Systems
- Full-Range Stereo Speakers (10W x 2)
- Digital Comb Filter and Noise Reduction
- V-Chip Parental Control
- Electronic Program Guide Support
- Multi-Language On-Screen Display
- Wall-Mountable Design

PACKAGE CONTENTS

Please make sure the following items are included with your LCD TV/monitor. If any items are missing, contact your local dealer.

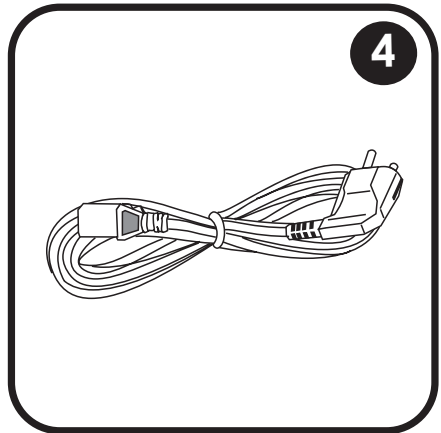
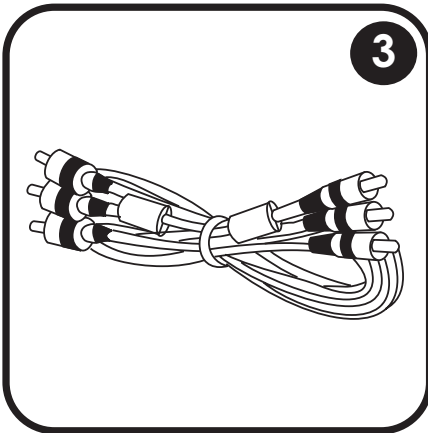
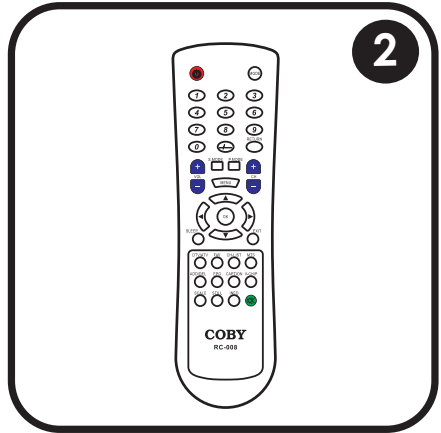
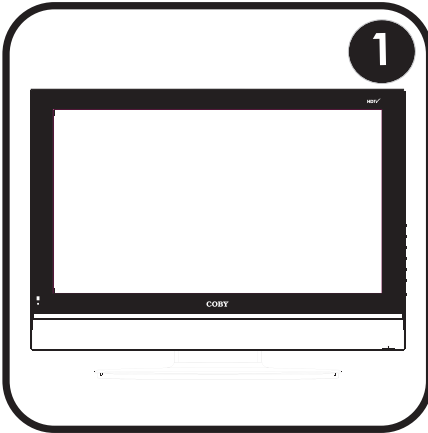

1. TF-TV3207
2. Remote Control
3. AV Cable
4. AC Power Cord

LOCATION OF CONTROLS

Front View

1. TFT LCD Display
2. Remote Sensor
3. Power Indicator
4. Stereo Speakers

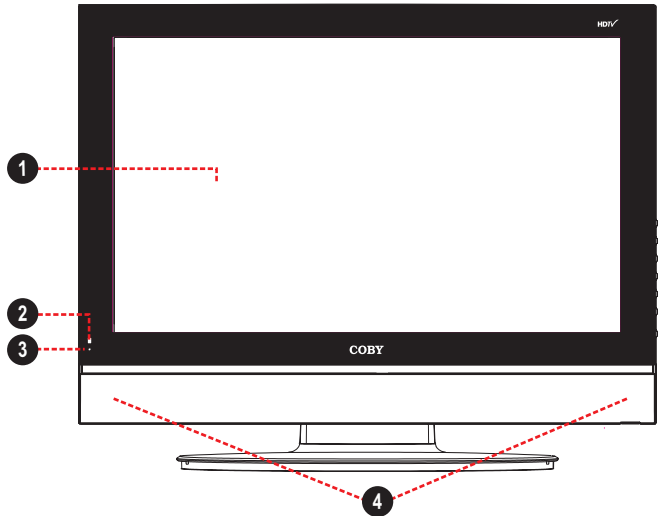

Right Panel View

1. Mode/Enter Button **MODE / OK**
2. Menu Button **MENU**
3. Channel Up Button **CH+**
4. Channel Down Button **CH-**
5. Volume Up Button **VOL-**
6. Volume Down Button **VOL+**
7. Power Button **⏻**

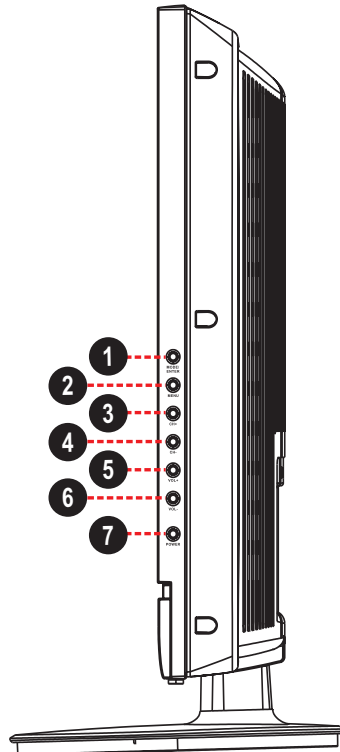

LOCATION OF CONTROLS

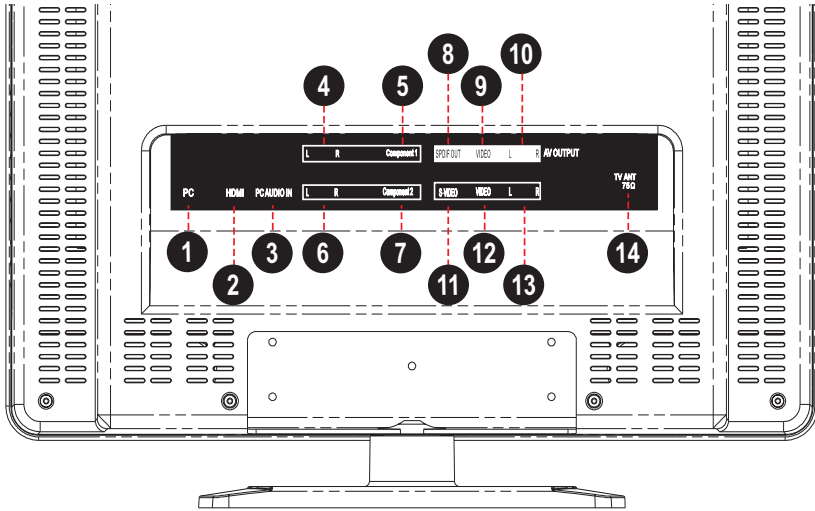

Rear Panel View

1. 15-pin D-sub VGA In (PC)
2. HDMI In (HDMI)
3. 3.5mm Audio In (PC Audio)

Component 1

4. *RCA Audio In (L/R): Use with Component Video 1*
5. *Component Video 1 In (Y, Cb/Pb, Cr/Pr)*

Component 2

6. *RCA Audio In (L/R): Use with Component Video 2*
7. *Component Video 2 In (Y, Cb/Pb, Cr/Pr)*

AV Out





























8. *SPDIF Digital Audio Out*
9. *Composite Video Out*
10. *RCA Audio Out (L/R):*

AV In (S-Video, Video, DTV, TV)

11. *S-Video In*
12. *Composite Video In*
13. *RCA Audio In (L/R): Use with S-Video or Composite Video In*
14. *75Ω Coaxial Antenna In (DTV, TV)*

LOCATION OF CONTROLS

Remote Control

1. **POWER** 
Turn the TV On/Off.
2. **MODE** 
Change the Video Input mode (Component, TV, Composite Video, S-Video, VGA).
3. **NUMERIC KEYPAD**
Change the channel directly.
Enter numeric input data.
4. **RETURN** 
Return to the most recently viewed channel.
5. **S.MODE** 
Change the Sound (audio) mode.
6. **P.MODE** 
Change the Picture (image) mode.
7. **Volume Up/Down**  / 
Adjust the Volume level.
8. **Channel Up/Down**  / 
Change the channel.
9. **MENU** 
Access the System Setup Menu.
10. **Navigation Keypad**
Move the selection cursor in the direction of the arrow:    .
Enter (confirm) a selection: .
11. **SLEEP** 
Set the Sleep timer.
12. **EXIT** 
Exit the System Setup menu.
13. **DTV/ATV** 
Change the TV Tuner mode (DTV or ATV).
14. **FAV** 
Access the Favorite Channels list.
15. **CH-LIST** 
Access the Channel Setup menu.
16. **MTS** 
TV Mode: Change the TV broadcast audio mode.
17. **ADD/DEL** 
Add or Delete a channel.
18. **EPG** 
Access the Electronic Program Guide.
19. **CAPTION** 
Change the Closed-Caption mode.
20. **V-CHIP** 
Change the V-Chip settings (this option is password protected).
21. **SCALE** 
Change the aspect-ratio mode (AUTO or 16:9)
22. **STILL** 
Freeze the picture.
23. **INFO** 
Display status information.
24. **MUTE** 
Turn the sound off or on.

LOCATION OF CONTROLS

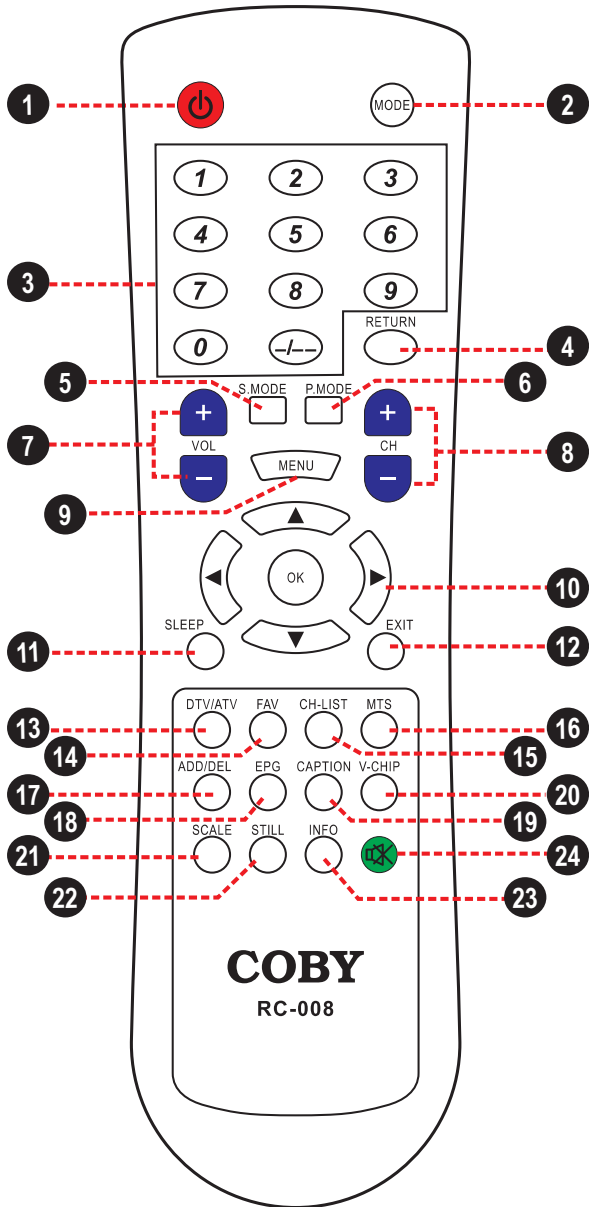

GETTING STARTED

Audio/Video Input Connections

TV Antenna (DTV, TV)

Connect TV sources to the Coaxial TV Antenna In jack. TV sources may include ATSC or NTSC cable/satellite lines, TV Tuner boxes, or Over-the-Air receiving antennas. You may use a 75 ohm coaxial cable to connect an outdoor antenna.

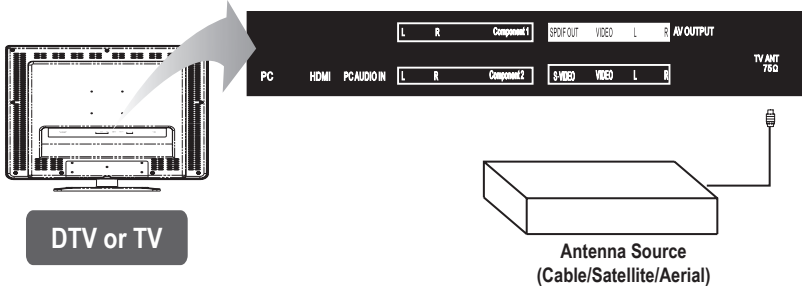

Composite Video or S-Video (Video, S-Video)

The Composite Video and S-Video jacks of the TV are capable of accepting signals from standard video sources (e.g., cable/satellite boxes, DVD players, VCRs, camcorders).

- Composite Video In (standard quality). Connect the yellow end of the AV cable to the yellow Video jack on the rear panel of the TV.
- S-Video In (better quality). If the video source has an S-Video output jack, use an S-Video cable (not supplied) to connect it to the input jack on the rear panel of the TV.
- RCA Stereo Audio. Connect the red and white end of the AV cable to the red and white Audio jacks on the rear panel of the TV.



Use either the Composite Video OR S-Video Connection. Do not use both connections at the same time.

Make sure you use the audio jacks that correspond with the Composite Video/S-Video jacks (AV In).

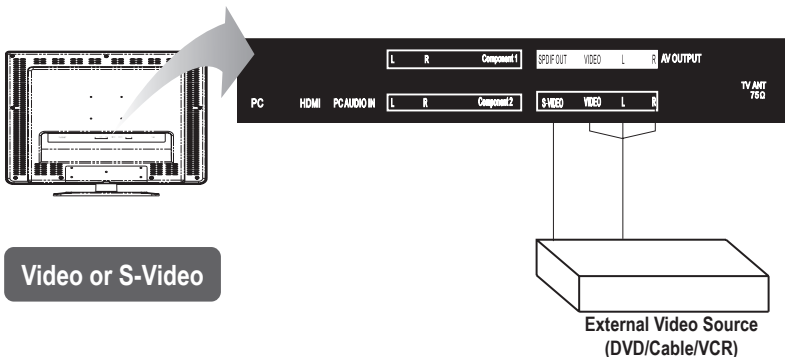

GETTING STARTED

Component Video (Component 1, Component 2)

The Component Video jacks of the TV are capable of accepting high-definition signals from standard video sources (e.g., cable/satellite boxes, DVD players, game consoles).

- Component Video In (best quality). If the video source has Component Video output jacks (Y/Pb/Pr), use a component video cable (not supplied) to connect it to the input jacks on the rear panel of the TV.
- RCA Stereo Audio. Connect the red and white end of the AV cable to the red and white Audio jacks on the rear panel of the TV.



Make sure you use the audio jacks that correspond with the Component Video jacks you are using (Component 1 or Component 2).

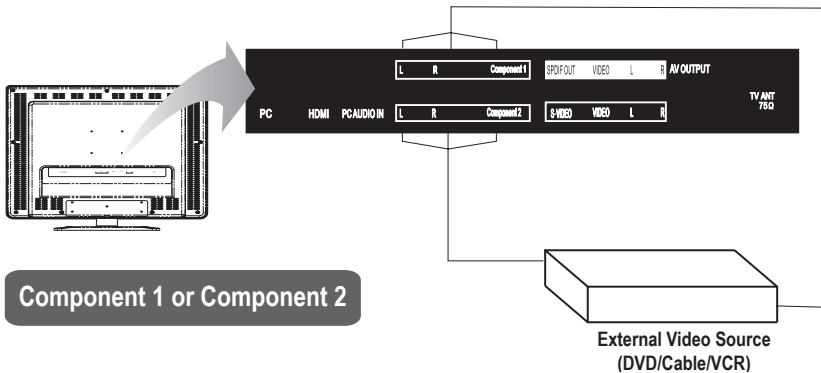

HDMI (HDMI)

HDMI (High Definition Multimedia Interface) is a new type of connection that transmits digital audio and video signals simultaneously over a single cable.

The HDMI jack of the TV is capable of accepting high-definition signals from audio/video sources equipped with an HDMI output jack (e.g., cable/satellite boxes, AV receivers, DVD players).

- HDMI In (best quality). If the video source has an HDMI output jack, use an HDMI cable (not supplied) to connect it to the input jack on the rear panel of the TV.

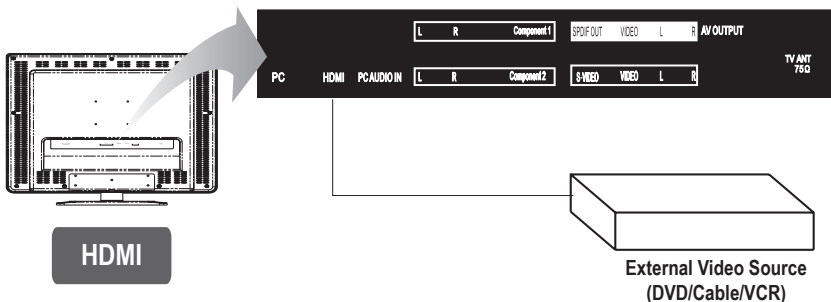

GETTING STARTED

15-Pin D-Sub (PC)

The VGA jack of the TV is capable of accepting high-definition signals from computers with a VGA output jack.

- 15-Pin D-Sub (best quality). If the computer has a VGA output jack, use a VGA cable (not supplied) to connect it to the input jack on the rear panel of the TV.
- 3.5mm Stereo Audio. If the computer has a 3.5mm Stereo output jack, use a 3.5mm male-to-male cable (not supplied) to connect it to the input jack on the rear panel of the TV.

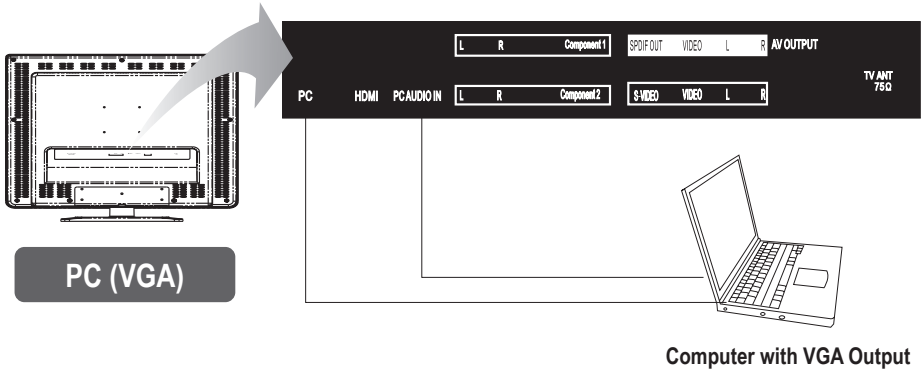

The recommended output resolution setting on your computer is 1366 x 768.

Audio/Video Output Connections

The AV output jacks of the TV are capable of transmitting audio or video signals to AV receivers, amplifiers or other TVs/monitors.

- Use the Digital Audio (SPDIF) out connection to output digital audio signals.
- Use the RCA Stereo Audio out connection to output analog audio signals.
- Use the Composite Video out connection to output analog video signals.



AV Output is available only in Video or TV mode.

Power Connection

Insert one end of the AC power cord to the Power input jack on the rear panel of the TV and the other end to an AC 100-240V wall outlet.



Make all Audio/Video Input or Output connections prior to connecting power.

GETTING STARTED

Remote Control

- Remove the battery compartment cover located on the rear of the remote control. Insert 2 x "AAA" batteries, making sure to match their polarities (+/-) to the markings on the inside of the compartment. Replace the cover.
- To use the remote, point it at the remote sensor of the player. Operate the remote within 15 feet of the sensor and at an angle of ± 30 degrees.
- Batteries in the remote will last for approximately 6 months under normal use. Replace the batteries if the remote control does not work. Do not mix old with new batteries, or different types of batteries.
- Remove the batteries from the remote if it will not be used for a long period of time.

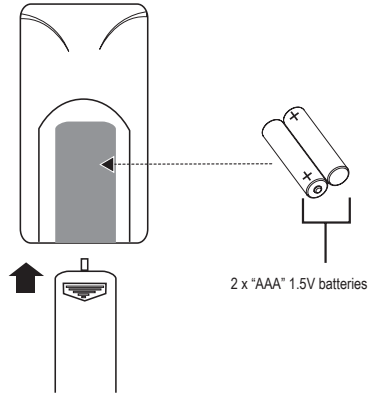

The battery used in this device may present a fire or chemical burn if mistreated. Do not recharge, disassemble, incinerate, or heat the battery (~212°F).

Keep batteries away from children.



Do not point bright lights directly at the remote control sensor.

Do not place objects between the remote control unit and the remote control sensor.

Do not use this remote control unit while simultaneously operating the remote control unit of any other equipment.

Power Management

If the TV will not be in use for a long period of time, turn the TV off and unplug it, and remove the batteries from the remote control.

TV FUNCTION

Basic Operation

1. Prepare the antenna and power connections (see the [Getting Started](#) section for details).
2. Press **⏻** to turn the TV on.
3. Set your TV to the display the desired signal.
 - Press **DTV/ATV** to change between Digital TV tuning (ATSC) or Analog TV tuning (NTSC).
 - Press **MODE** to change between AV Input or Output modes (Component 1, Component 2, AV Out, etc.). You should see the desired signal on-screen.
4. Press **CH+** or **CH-** to change the channel, or use the numeric keypad on the remote control to input a channel number directly.



*Prior to viewing over-the-air or cable/satellite television, it is recommended that you set the television to auto-scan for available station channels. To auto-scan, press **MENU** to enter the System Setup Menu, and then select "Channel > Auto Program".*

System Setup Menu

Access the System Setup Menu to adjust the internal options and features of your TV.

1. Press **MENU**. The System Setup Menu will appear on-screen.
2. Use the Navigation keypad (**⏪** or **⏩**) to select a setup menu category. Press **OK** to enter the selected setup menu.
 - With a setup menu, press **▲** or **▼** to select (highlight) a desired option. Press **OK** to confirm the selection.
 - Press **⏪** or **⏩** to adjust an option.
3. Press **EXIT** to return to a previous menu and to exit the System Setup Menu.

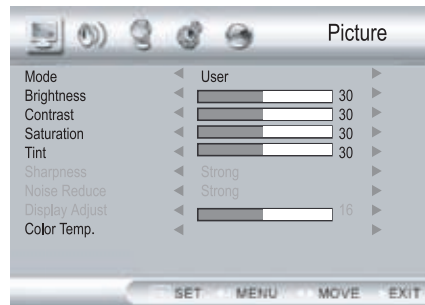

Picture Options Menu

Item	Description
Mode	Select a Picture Mode preset (User, Standard, Movie, Sports)
Brightness	Adjust the brightness of the display.
Contrast	Adjust the contrast of the display.
Saturation	Adjust the color saturation of the display.
Tint	Adjust the tint of the display.
Sharpness	ATV Mode only: Adjust the sharpness of the display.
Noise Reduce	ATV Mode only: Select the Noise Reduction mode (Off, Lower, Middle, Strong).
Color Temp.	Adjust the color temperature of the display.

TV FUNCTION

Audio Options Menu

Item	Description
Effect	Select an Audio Effect preset (Speed, Music, User, Standard, Movie).
EQ120,500,1500, 5K, 10K	Adjust the audio equalizer bands.
Balance	Adjust the channel balance of the audio mix.
MTS	Set the MTS (Multi-channel Television Sound) audio mode.
S/PDIF	Set the Digital Audio output mode (Dolby or PCM).

Channel Options Menu

Item	Description
TV Source	Set the ATV (NTSC) tuning mode: AIR Cable (STD), Cable (HRC), Cable (IRC).
DTV Source	Set the DTV (ATSC) tuning mode: AIR Cable (STD), Cable (HRC), Cable (IRC).
Auto Program	Select to search and store all available broadcast channels.
Auto Searching	Select to search and store all available broadcast channels.
Favorites	Edit the Favorite Channels list to skip unwanted channels.
Fine Tune	ATV Mode only: Adjust the tuning of a station channel

Setup Options Menu

Item	Description
Language	Select the OSD menu language
Input	Select the input mode: Video, S-Video, Component 1, Component 2, HDMI, PC, DTV, TV.
Screen Format	Set the screen format: Full, Auto.
Closed Caption	Set the Closed Caption mode.
V-Chip	Set the Parental Lock Controls.
Transparents	Adjust the menu transparency effect.
Miscellaneous	Display firmware information.

TV FUNCTION

Time Options Menu

Item	Description
Time Zone	Select the OSD menu language
Day Light Saving	Toggle the automatic daylight savings time adjustment on or off.
Sleep	Set the Sleep Timer function.

Favorite Channels List

Press **FAV** to access the Favorite Channels list. To save frequently accessed channels to the list:

1. Enter the System Setup menu (press **MENU**).
2. Enter the Channel Options menu and select "Favorites".

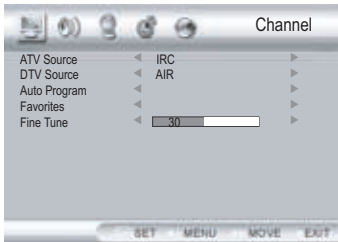

3. Use the Navigation keypad to adjust the Favorites option for the selected channel.



TV FUNCTION

Parental Control (V-Chip Lock)

Lock selected channels or program types to restrict access to objectionable content. To set the Parental Control options:

The Parental Control menu is password-protected. When the Parental Control menu is selected:

1. Enter the System Setup menu (press **MENU**).
2. Enter the Setup Options menu and select "V-Chip".

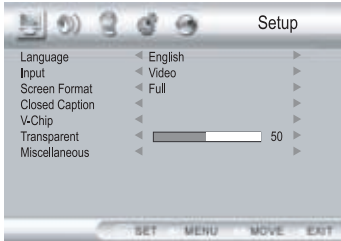

3. A Password Input screen will appear. Use the Numeric Keypad to enter the 4-digit password to access the V-Chip options..

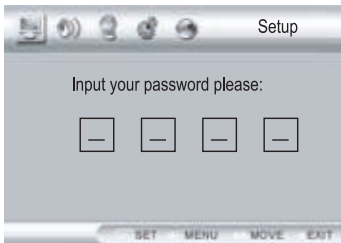

*The initial default password is "0000".
DO NOT FORGET THE PASSWORD; the V-Chip password cannot be reset.*

4. When the correct password has been entered, the V-Chip option screen will appear. Consult the following table for a description of the V-Chip options.



TV FUNCTION

Item	Description
Parental Lock	Turn the Parental Lock controls On or Off.
Clear All	Remove current Parental Lock restrictions
Parent Guide	Set TV rating restrictions: TV-Y, TV-Y7, TV-G, TV-PG, TV-14, TV-MA.
MPAA	Set Movie rating restrictions: G, PG, PG13, R, NC17, X, NR.
Change PIN	Change the Parental Lock password. You will need to enter the old password first to access this option. DO NOT FORGET THE PASSWORD; this password cannot be reset.

Parent Guide Options (TV Rating)

TV broadcasts include a signal that classifies the contents of the program. When the TV Rating control is set, TV broadcasts that have been classified with a higher rating will be blocked.

- None/Off: no restrictions (lowest rating)
- TV-Y: All children
- TV-Y7: For children aged 7 and above
- TV-G: General Audience
- TV-PG: Parental Guidance suggested
- TV-14: Not intended for ages under 14
- TV-MA: For mature audiences only (highest rating).

The TV broadcast rating may include the following sub-categories:

- D: Suggestive dialogue
- L: Indecent language
- S: Sexual situations
- V: Violence

MPAA Options (Movie Rating)

TV broadcasts include a signal that classifies the contents of the program. When the Movie Rating control is set, movie broadcasts that have been classified with a higher rating will be blocked.

- NA: no restrictions (lowest rating)
- G: General Audience
- PG: Parental Guidance suggested
- PG-13: Not intended for ages under 13
- R: Restricted
- NC-17: Not intended for ages under 17
- X: For adults only (highest rating).

AV FUNCTION

Basic Operation

Use the AV Input modes to view external video sources on the TV. Video sources may include satellite/cable boxes, DVD players, video game consoles, VCRs, DVRs, camcorders, and more.

1. Connect the external video source to the proper input jacks and prepare the power connections (see the [Getting Started](#) section for details).
2. Press **⏻** to turn the TV on. Turn on the external video source.
3. Set your TV to the display the desired signal.
 - Press **MODE** to change between AV Input or Output modes (Component 1, Component 2, HDMI, AV Out, etc.). You should see the external video signal on-screen.

System Setup Menu (AV Mode)

Access the System Setup Menu to adjust the internal options and features of your TV.

1. Press **MENU**. The System Setup Menu will appear on-screen.
2. Use the Navigation keypad (**⬅** or **➡**) to select a setup menu category. Press **OK** to enter the selected setup menu.
 - With a setup menu, press **▲** or **▼** to select (highlight) a desired option. Press **OK** to confirm the selection.
 - Press **⬅** or **➡** to adjust an option.
3. Press **EXIT** to return to a previous menu and to exit the System Setup Menu.

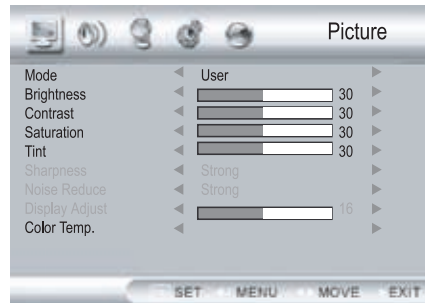

Picture Options Menu

Item	Description
Mode	Select a Picture Mode preset (User, Standard, Movie, Sports)
Brightness	Adjust the brightness of the display.
Contrast	Adjust the contrast of the display.
Saturation	Adjust the color saturation of the display.
Tint	Adjust the tint of the display (Component 1 and Component 2 only).
Sharpness	ATV Mode only: Adjust the sharpness of the display.
Noise Reduce	ATV Mode only: Select the Noise Reduction mode (Off, Lower, Middle, Strong).
Color Temp.	Adjust the color temperature of the display.

AV FUNCTION

Audio Options Menu

Item	Description
Effect	Select an Audio Effect preset (Speed, Music, User, Standard, Movie).
EQ120, 500, 1500, 5K, 10K	Adjust the audio equalizer bands.
Balance	Adjust the channel balance of the audio mix.
MTS	Set the MTS (Multi-channel Television Sound) audio mode.
S/PDIF	Set the Digital Audio output mode (Dolby or PCM).

Setup Options Menu

Item	Description
Language	Select the OSD menu language
Input	Select the input mode: Video, S-Video, Component 1, Component 2, HDMI, PC, DTV, TV.
Screen Format	Set the screen format: Full, Auto.
Closed Caption	Set the Closed Caption mode (Video and S-Video mode only).
V-Chip	Set the Parental Lock Controls (Video and S-Video mode only). Please refer to the section "TV Function > Parental Control (V-Chip Lock)" for more information.
Transparents	Adjust the menu transparency effect.
Miscellaneous	Display firmware information.

Time Options Menu

Item	Description
Sleep	Set the Sleep Timer function.

PC VGA FUNCTION

Basic Operation

You can use this TV as a display monitor for a computer through a 15-pin D-Sub VGA connection.

1. With both the TV and computer off, prepare the VGA Input and power connections (see the [Getting Started](#) section for details). You will need to use an optional VGA cable.
2. Press **⏻** to turn the TV on. Turn on your PC.
3. Press **MODE** to set the TV to VGA mode. You should see the PC VGA video input signal on-screen.

System Setup Menu (PC Mode)

Access the System Setup Menu to adjust the internal options and features of your TV.

1. Press **MENU**. The System Setup Menu will appear on-screen.
2. Use the Navigation keypad (**⬅** or **➡**) to select a setup menu category. Press **OK** to enter the selected setup menu.
 - With a setup menu, press **▲** or **▼** to select (highlight) a desired option. Press **OK** to confirm the selection.
 - Press **⬅** or **➡** to adjust an option.
3. Press **EXIT** to return to a previous menu and to exit the System Setup Menu.

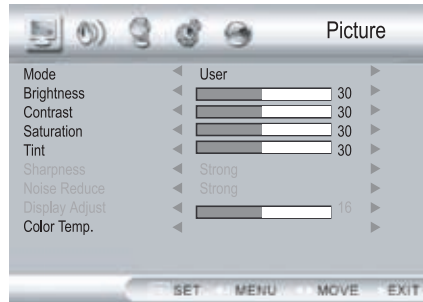

Picture Options Menu

Item	Description
Mode	Select a Picture Mode preset (User, Standard, Movie, Sports)
Brightness	Adjust the brightness of the display.
Contrast	Adjust the contrast of the display.
Saturation	Adjust the color saturation of the display.
Display Adjust	Adjust the quality of the display.
Color Temp.	Adjust the color temperature of the display.

PC VGA FUNCTION

Audio Options Menu

Item	Description
Effect	Select an Audio Effect preset (Speed, Music, User, Standard, Movie).
EQ120, 500, 1500, 5K, 10K	Adjust the audio equalizer bands.
Balance	Adjust the channel balance of the audio mix.
S/PDIF	Set the Digital Audio output mode (Dolby or PCM).

Setup Options Menu

Item	Description
Language	Select the OSD menu language
Input	Select the input mode: Video, S-Video, Component 1, Component 2, HDMI, PC, DTV, TV.
Screen Format	Set the screen format: Full, Auto.
Transparents	Adjust the menu transparency effect.
Miscellaneous	Display firmware information.

Time Options Menu

Item	Description
Sleep	Set the Sleep Timer function.

TROUBLESHOOTING

If you have a problem with this TV, please read the troubleshooting guide below and check our website at www.cobyusa.com for Frequently Asked Questions (FAQs) and firmware updates. If these resources do not resolve the problem, please contact Technical Support.

COBY Electronics Technical Support

Address: 56-65 Rust St.
Maspeth, NY 11378

Hours: 8:00 AM–11:00 PM EST, seven days a week

Phone: 718-416-3197 or 800-681-2629

Email: techsupport@cobyusa.com

Web: www.cobyusa.com

There is no power to the device.

- Ensure that the Power Switch is physically set to the ON position.
- Ensure that the AC adapter cord is securely connected to the TV and the proper wall outlet.
- Ensure that the main power has been switched on.

There is no picture.

- Ensure that the connections between the player and the TV are secure and correct.
- Ensure that the TV set has been powered on and is set to the correct AV mode.
- Try another TV broadcast channel.
- Ensure that the Parental Guide (TV) and MPAA (Movie) rating levels do not exceed that of the TV broadcast.
- Check if the connection cables are damaged.

The picture is noisy or distorted.

- Reset your TV's color system.
- If an antenna is in use, try repositioning it for better reception.
- Ensure that the aspect ratio of the television matches the aspect ratio of the video source (e.g., TV antenna, cable box, VCR, etc.). To set the aspect ratio of the TV, enter the System Setup Menu by pressing Menu, and then change Setup > Screen Format option.

There is no sound or distorted sound.

- Ensure that the TV and amplifier have been turned on and properly set up.
- Ensure that the TV and amplifier connections are secure and correct.
- Ensure that the MUTE function of the TV, Amplifier, or Player is not engaged.

The remote control doesn't work.

- Ensure that there are no obstacles between the remote and the player.
- Point the remote at the remote sensor on the main unit.
- Ensure that the batteries in the remote retain a charge and have been installed correctly.
- Try replacing the remote's batteries.

TROUBLESHOOTING

The unit has malfunctioned.

- Unplug the TV and let it rest for 30 minutes. Plug it back in; the restore function should reset the TV.

SPECIFICATIONS

Display Type	32" Widescreen TFT LCD
Display Resolution	1366 x 768
Display Contrast	1600:1
Brightness	500 cd/m ²
Pixel Pitch	0.1455mm (H) x 0.4365mm (V)
Pixel Response Time	8ms
TV System	ATSC, NTSC-M
Antenna Impedance	75Ω unbalanced
Audio/Video Input	HDMI-HDCP 15-pin D-Sub (PC VGA) + 3.5mm Stereo (PC Audio) Component Video 1 + RCA Stereo Audio Component Video 2 + RCA Stereo Audio Composite Video / S-Video + RCA Stereo Audio (shared)
Audio/Video Output	Composite Video + RCA Stereo Audio Coaxial Digital Audio (SPDIF) Speakers: 10W x 2
Operating Temperature	50°F - 104°F
Power Supply	AC 100-240V 50/60Hz
Power Consumption	Working: 35W (max) Standby: <1.1W
Unit Dimensions	18.6" x 15.1" x 6.1" (WHD)
Weight	11.7 lbs

Design, specifications, and manual are subject to change without prior notice.

NOTES

NOTES

COBY Electronics Corp.

56-65 Rust Street
Maspeth, NY 11378

www.cobyusa.com
www.ecoby.com